



App Note: DLS-03

**Ultra-Narrow Linewidth Laser
DL-CLS101B-S1550**

1. Mode-Hop-Free Operation

1.1 The DL-CLS product when properly applied is mode-hop-free. DL-CLS101B-S1550 laser requires specific setup to achieve best performance. Please review this application note, the datasheet, and the Out Going Report (shipped along with the unit) before setting up and testing the laser. Each laser has a recommended TEC temperature* set point which is indicated in the OGR. The recommended TEC temperature has to be maintained to provide optimal performance. Typical wavelength vs. TEC temperature characteristics at case temperature equal to 25°C are presented in Figure 1.

*TEC Temperature refers to the Laser Die temperature measured by the thermistor (BTF Pins 2, 5) . #Tcase temperature refers to ambient or external room temperature , as sensed on the BTF package .

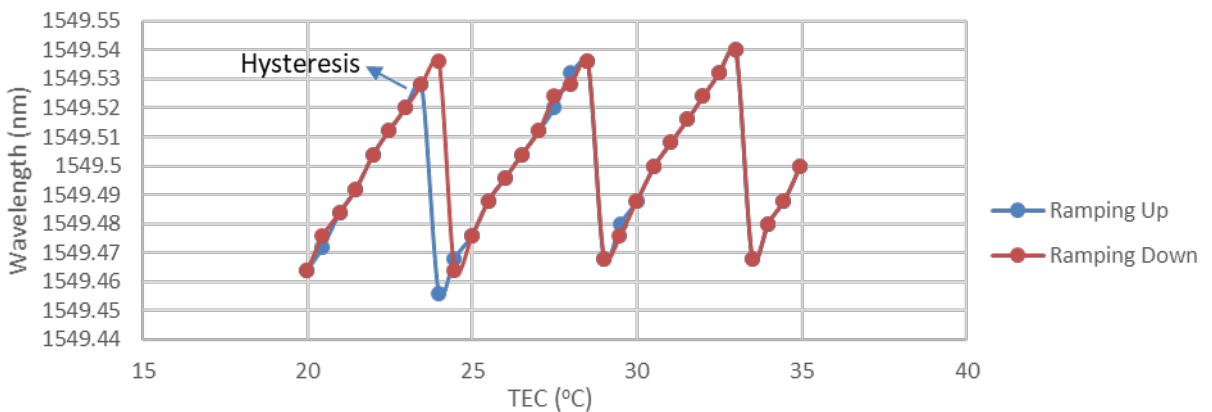

Figure 1. Wavelength vs. TEC temperature characteristics with very small hysteresis region.

1.2 Figure 1 shows a very small hysteresis in wavelength vs. laser temperature characteristics, when compared to other manufacturers, who have large hysteresis. During initial setting, some spectral distortions may be observed (e.g. double peak or low SMSR). This is an indication that the temperature is outside of the recommended range. This initial setting has to be done manually using this application note and the OGR as a guideline. Alternatively, the customer can also purchase DenseLight’s BF9 product series to have this laser operate at its best performance. As long as the TEC is tuned to the recommended value, a single longitudinal mode spectrum with excellent power and wavelength stability can be achieved when the laser is biased, as can be seen in the next section.

1.2 DL-CLS101B-S1550 laser performances (operating in DenseLight's BF9)

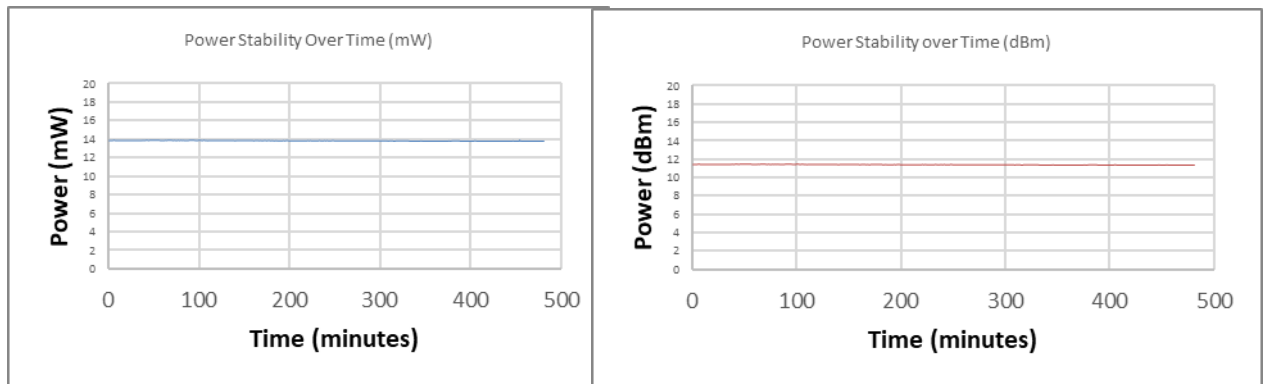

Figure 2. Power stability over time for 8 hours (operating in DenseLight's BF9)

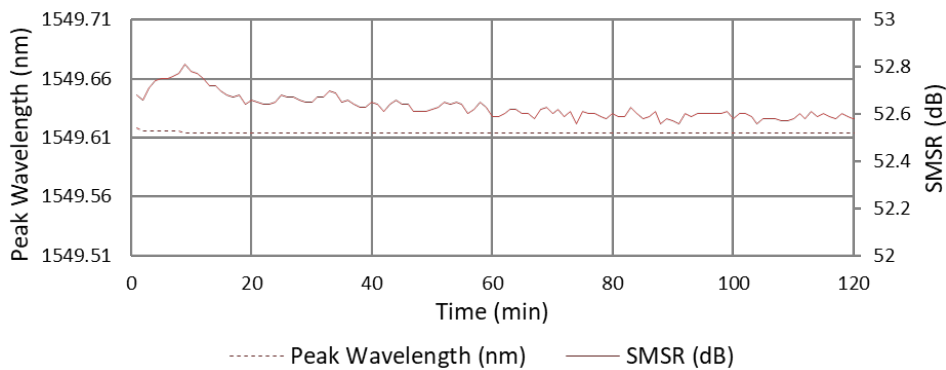

Figure 3. Wavelength stability and SMSR over time for 2 hours at room temperature (operating in DenseLight's BF9)

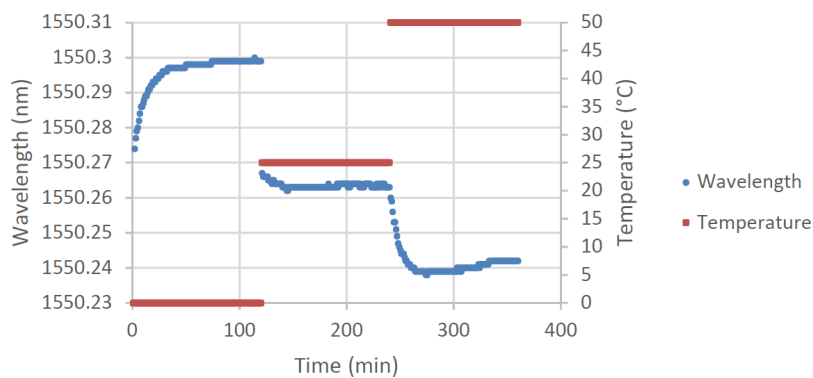

Figure 4. Wavelength stability over time at 0°C, 25°C, and 50°C ambient temperature (operating in DenseLight's BF9)

2. Guide to operate for Mode-Hop-Free

2.1 Mode-hop-free window characteristics to Ambient temperature

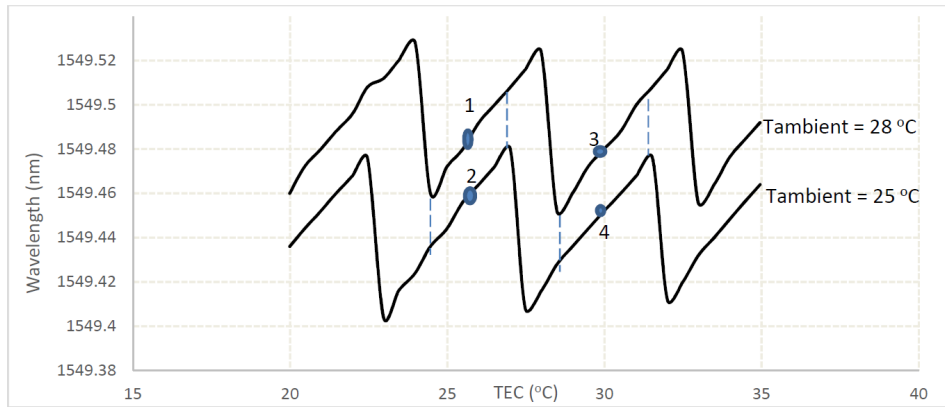

Figure 5 The recommended operating points are shown by (3) for $T_{case}=28\text{ }^{\circ}\text{C}$ and (4) for $T_{case}=25\text{ }^{\circ}\text{C}$ when the TEC is $30\text{ }^{\circ}\text{C}$

When the laser is used under different ambient temperature, its operating wavelength may slightly shift. This section describes the shift in wavelength for a range in temperature. As shown in figure 5, the laser is tested at 2 different ambient temperatures, $25\text{ }^{\circ}\text{C}$ and $28\text{ }^{\circ}\text{C}$. For simplicity, the data shown is only for ramping up TEC as the ramping down profile is not very different. From these 2 plots, the recommended TEC point is the middle point of the section which has largest TEC window. For this specific example, the recommended TEC is $30\text{ }^{\circ}\text{C}$. The laser will operate at 1549.48nm when the $T_{ambient} = 28\text{ }^{\circ}\text{C}$ and 1549.45nm at $T_{ambient} = 25\text{ }^{\circ}\text{C}$

3. Linewidth Measurement and Setup

3.1 Linewidth measurement of a Narrow-Linewidth laser ($\ll 1\text{nm}$) cannot be done accurately by typical grating based Optical Spectrum Analyzer due to resolution limitation. DenseLight uses Self Heterodyne detection method to measure the narrow linewidth. Self-heterodyne measurement method is based on a beating between the laser's beam and a delayed version of itself. The spectrum analyzer displays the linewidth reading and to get more accurate linewidth data, the raw data is extracted and analyzed. (Reference 1)

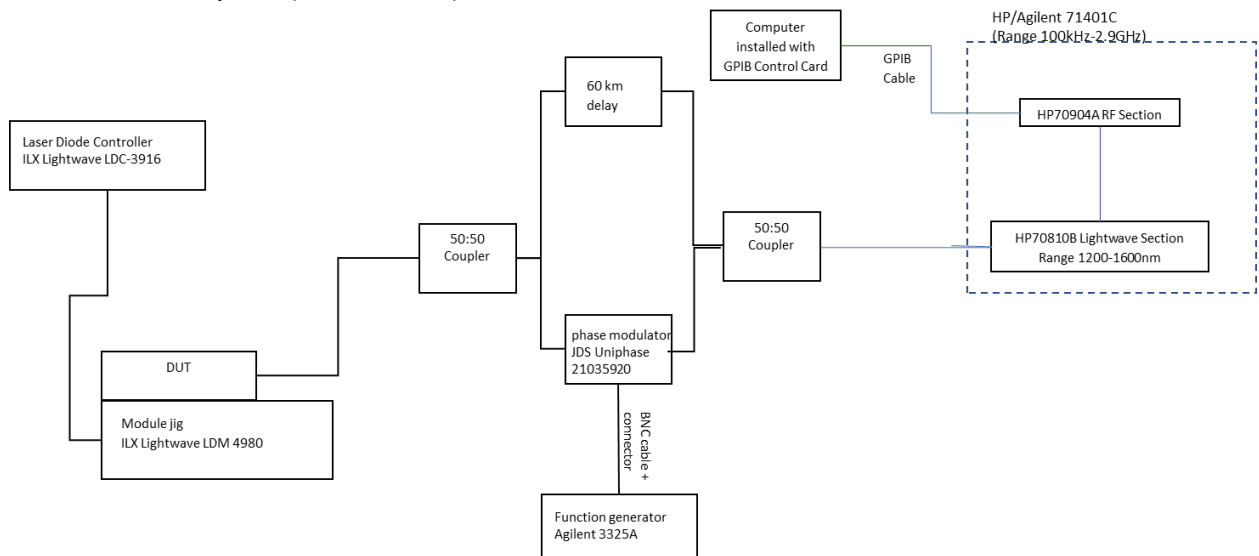

Figure 6. Linewidth test setup

1. Chen, Xiaopei. Ultra-narrow laser linewidth measurement. Diss. Virginia Polytechnic Institute and State University, 2006.

Measurement type	Function Generator Setting	Monitor Waveform LSA Setting
100 kHz span measurement	RAMP waveform Frequency = 1 MHz Amplitude = 9Vp-p Offset = 0 Vdc Symmetry = 100%	Center = 1 MHz Span = 100kHz Resolution Bandwidth = 1 kHz

The example of the raw data obtained are plotted and shown in figure 7. This data is then shifted to 0 Hz from 1MHz. Then, by using Lorentzian curve fitting function (available in Origin Software) the FWHM of this plot is obtained. It is displayed as w, and the linewidth itself is half of this value. The example is shown in figure 8 which shows w=11993Hz and thus the linewidth = 5996.5 Hz.

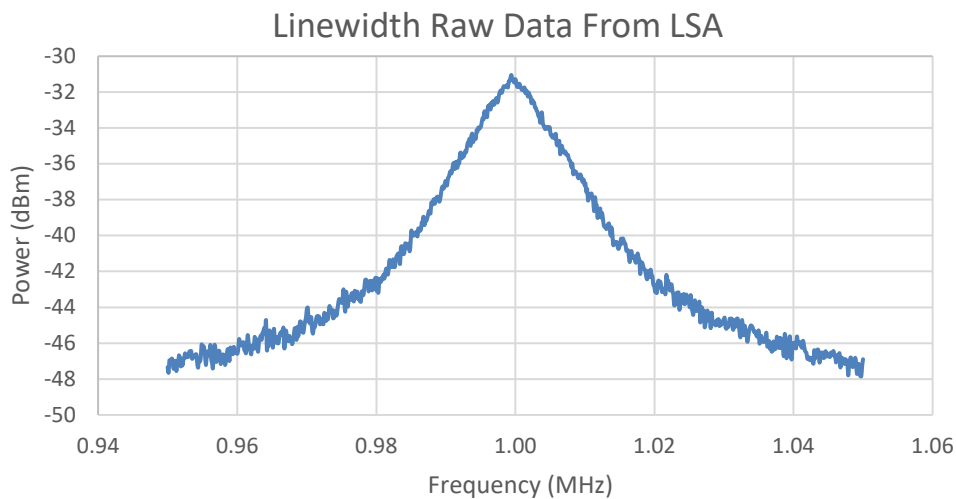

Figure 7. Plotting of linewidth raw data

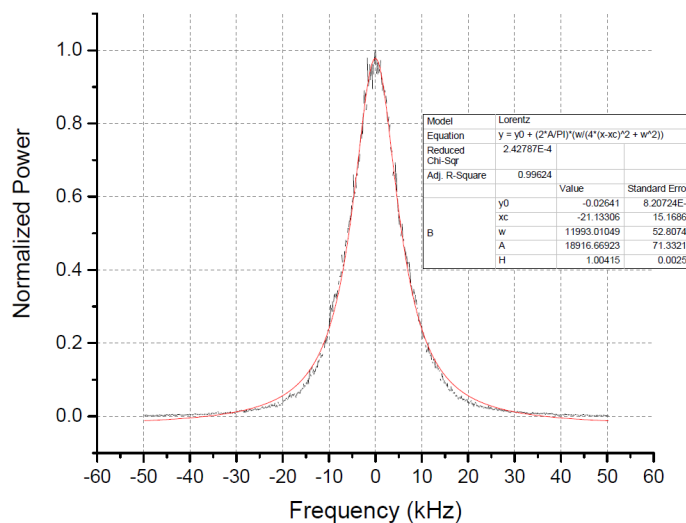

Figure 8 Lorentzian Fitting by using Origin Software

4. RIN Measurement and Setup

4.1 The measurement of relative intensity noise (RIN) describes the laser’s maximum available amplitude range for signal modulation and serves as a quality indicator of laser devices. RIN can be thought of as a type of inverse carrier-to-noise-ratio measurement. RIN is the ratio of the mean-square optical intensity noise to the square of the average optical power:

$$RIN = \frac{\langle \Delta P^2 \rangle}{P^2} \text{ dB/Hz}$$

$\langle \Delta P^2 \rangle$ is the mean-square optical intensity fluctuation (in a 1-Hz bandwidth) at a specified frequency, P is the average optical power. (Reference 2)

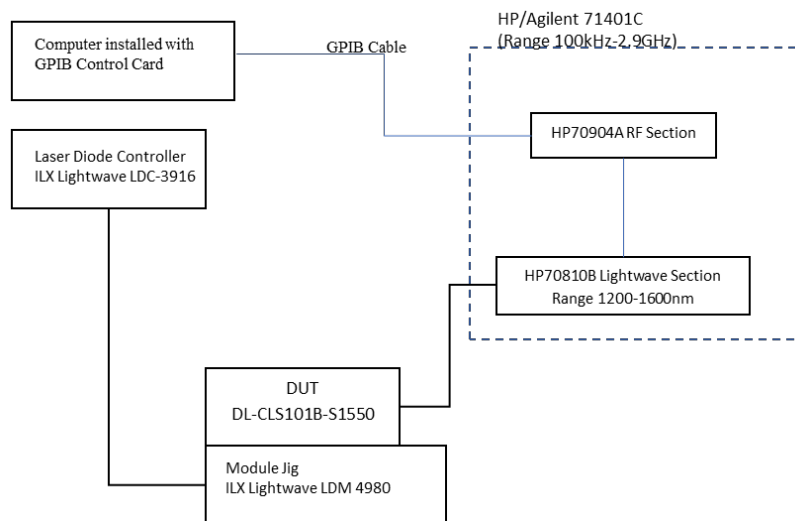

Figure 9 RIN Measurement Setup

HP 71401C LSA has its own internal capability of measuring RIN. It also has capability of displaying the RIN value at specific frequency of the device under test (DUT). To get the value for a certain range of frequency, RIN is plotted from the extracted the raw data. The typical RIN of our laser is shown in figure 10 which shows average value around -140 dB/Hz in range of 5-50MHz.

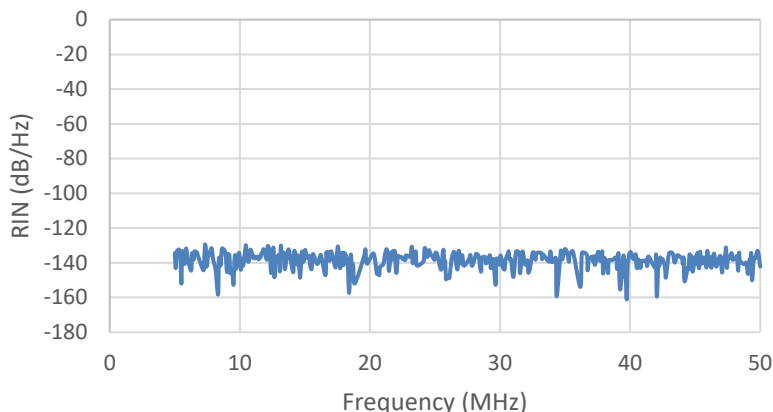

Figure 10. Typical RIN in 5 to 50MHz frequency